



# Foxy R1 & R2

FRACTION COLLECTORS



# R1 & R2

## Fraction Collectors

**Foxy R1 and Foxy R2 fraction collectors are ideal for applications including prep HPLC, protein, and peptide purifications.**

The basic model, Foxy R1, uses a single collection rack for a small footprint. The Foxy R2 doubles the collection capacity, and uses Radio Frequency Identification (RFID) for error-free rack configuration.

Foxy R1



Foxy R2



### Reliable and Easy to Use

1. Symbolic touch screen display for quick setup
2. Diverter valve with contained flow path
3. 1,000 mL/min diverter valve available
4. Integral drop former virtually eliminates delay volume
5. Drip tray provides secondary containment for safety
6. Grounded for organic compatible collection
7. Robust, single piece cast aluminum frame creates a reliable collector

*Foxy product color may vary from photographs.*

# Get the Peaks You Want

Collect only the peaks you want by programming desired peak detector options.



## Level Sensing

Collect peaks above detector threshold, enabling "heart-cut" collection of concentrated part of the peak.

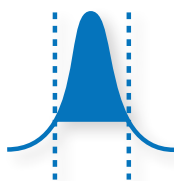

## Slope

Collect peaks based on inflection points. Separate close peaks by valley triggers.

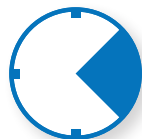

## Time Window

Collect only during a specific interval of time.



## Delay Compensation

Cut peaks at the diverter valve regardless of system tubing lengths.

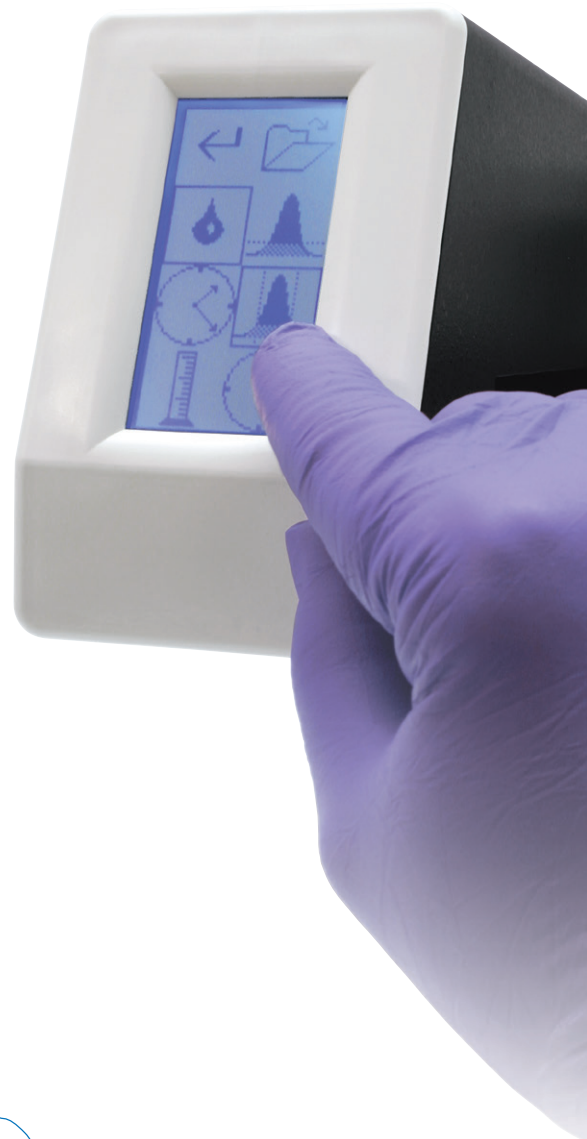

By combining Teledyne ISCO's accurate peak detection with uniform fraction options, desired peaks may be collected, diverting other peaks and baseline effluent to waste.

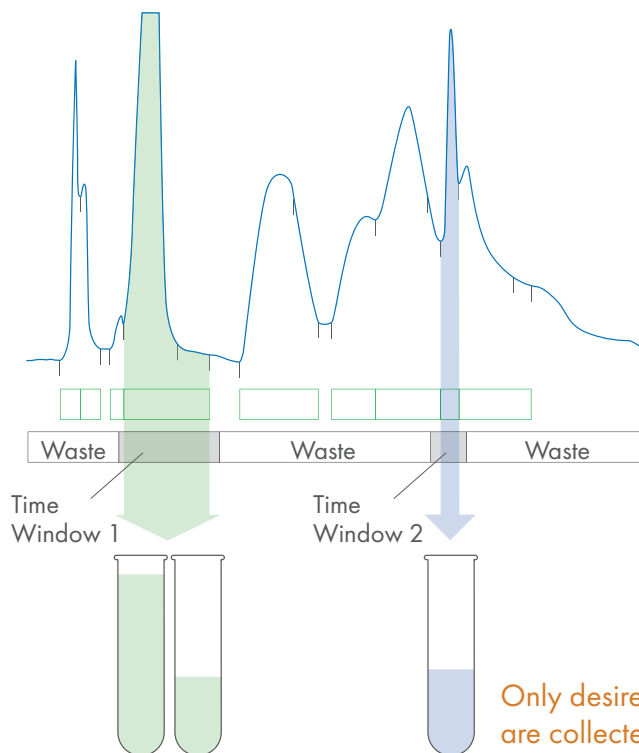

## Slope-detected peaks

Time windows bracket desired peak fluids

Only desired peaks are collected

# Versatile Selection of Racks

Collect your fractions in the vessel type best suited for your application.

For large volume collection, bottles and funnels enable virtually unlimited sample collection. Racks now include RFID tags for fast and accurate setup on the Foxy R2 fraction collector. The Foxy R1 and R2 use the same convenient, lift-out racks as the legacy Foxy Jr. and Foxy 200 fraction collectors.

The rigid and warp-proof racks are made from stainless steel and polypropylene. Funnel racks uses chemically resistant ETFE or ECTFE, and are available with tubing for organic as well as inorganic applications.



1. 12–13 mm Tubes
2. 16–25 mm Tubes
3. Bottles
4. Funnel Racks
5. Scintillation Vials
6. Microcentrifuge Tubes

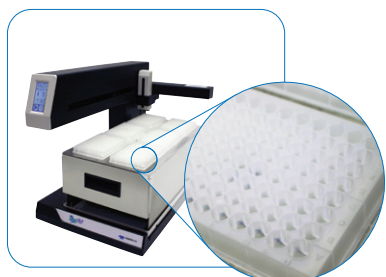

**96 Well Plates**  
Hold up to six on the  
Foxy R2



**Funnel Racks**  
Collect unlimited volumes

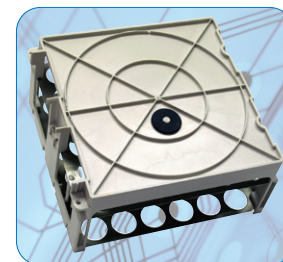

**RFID Tags**  
Automatically configure  
the Foxy R2

# Flexible Collection Options

User-selectable options such as collection patterns, injection restarts, and arm movement speed allow you to tailor the fraction collector operation to your specific collection needs.



## Tube-to-tube Speed

Select from five available speed settings.

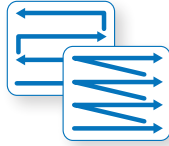

## Collection Patterns

Use serpentine patterns for fast row-to-row changes; L-R patterns for easy-to-find fractions.



## Multiple Injections

Collect from multiple purification runs restarted at regular time intervals or at Inject Pulse signals. When using multiple injections the **Restart Options** let you concentrate fractions or create tube groups.

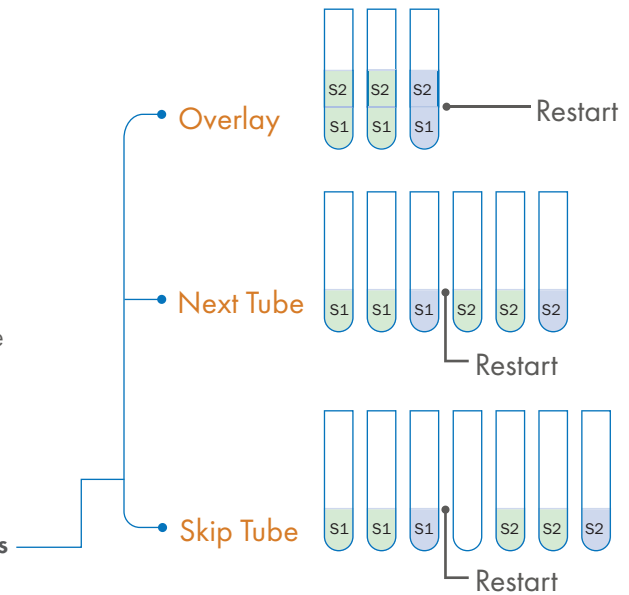

# Easily Interface with Systems

Rear panel connectors on the Foxy R1 and R2 fraction collectors support system integration with external pumps and detectors.

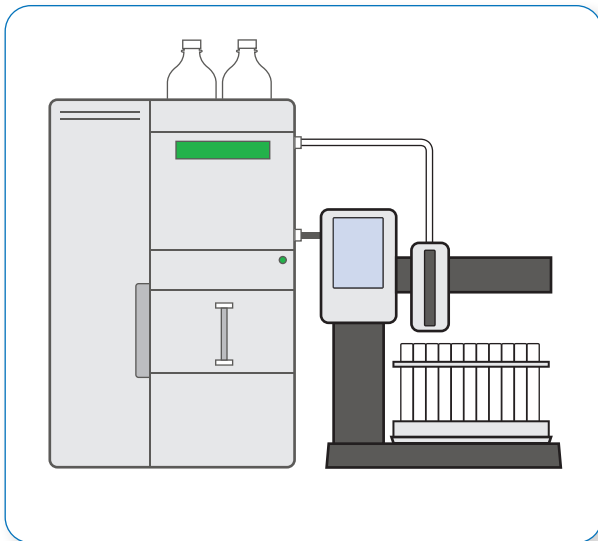

## Detector I/O Signals

- Analog Peak In
- Inject Pulse In
- External Peak In
- Tube Advance In
- Event Out

## Pump I/O Signals

- Volume Count In
- Pause/Stop Out

For easy connection to a system controller, the fraction collectors support Ethernet and RS-232 communications. An extensive library of commands allow remote operation under software control.

**Contact Teledyne ISCO to discuss OEM Fraction Collector options for integration with your purification systems.**

# Fraction Collector Selection Guide

	Foxy R1	Foxy R2	High Flow Foxy R2
Inlet Tubing and Flow Rates	1/16" OD (0.031" ID), up to 25 mL/min (25 to 125 mL/min with high flow option)	1/8" OD (0.062" ID), 25–125 mL/min (up to 25 mL/min with low flow option)	1/4" OD (0.125" ID), up to 1 L/min
Maximum Tube Height	160 mm	196 mm	180 mm
Racks	1, no detection	2, with RFID	2, with RFID
Maximum Tube Qty	144 12/13 mm tubes	288 12/13 mm tubes	
Max Fraction Volume	Unlimited with funnel racks		
Construction Materials:	Stainless steel and polypropylene		
Racks	ECTFE (Halar) or ETFE (Tefzel) funnels		
Funnel Racks	PEEK and FFKM (fluoroelastomer)		
Diverter Valve	Cast Aluminum		
Construction	Polypropylene		
Drip Tray	PEEK		
Drop Former			
Solvent Compatibility	Aqueous and Organic		
Test Tube Time Change	0.10–0.58 seconds (dependent on collection vessel tube advance speed)		
Memory	Eight methods		
Collection Modes: Time	00:00:01–99:59:59, 1 second intervals		
Drop	1–999 drops per fraction		
Volume	Up to 999 units		
Peak Detection	Slope, Threshold, Three time windows, Combination of any of the above collection modes		
System Control	Front panel touch screen, Ethernet or RS-232		
Inputs	Pump counter, external peak, inject, tube advance: +3.3 to 5 VDC or contact closure, active low, 30 ms minimum, 5 VDC max. Analog peak voltage: 0 to 1.0 V nominal, –1.2 to +1.2 V usable, –5 to +5 V max.		
Outputs	Pump pause/stop and event (tube change), 300 ms: open collector, active low, 15 VDC/100 mA maximum.		
Automatic Shut-off	Rack full, last tube, end of time window or external signal		
Security Valve (2-way)	n/a		
Diverter Valve (3-way)	Included		
Valve Pressure Rating	0–28 psi		
Dimension: WxHxD	12.25 x 14.0 x 13.0 in 31.1 x 35.5 x 33.0 cm	12.25 x 14.9 x 21.0 in 31.1 x 37.8 x 53.3 cm	12.25 x 15.5 x 21.0 in 31.1 x 39.4 x 53.3 cm
Weight	7.1 kg (15.6 lbs)	10.3 kg (22.8 lbs)	10.4 kg (22.9 lbs)
Power Requirements	100–240 VAC, 50–60 Hz, 1 ampere max. Includes one IEC power cord supplied for regional AC power (100, 117, 234 VAC)		
Certification	CE, CSA		

# Ordering Information

## Foxy R2 and Foxy R1

Foxy R1 fraction collector with diverter valve: Includes 1/16-inch OD (0.031 ID) tubing for collection up to 25 mL/min and (1) rack for 13 mm tubes. Other racks may be substituted; specify racks when ordering .....68-3870-012

Foxy R2 fraction collector with diverter valve: Includes 1/8-inch OD (0.062 ID) tubing for collection up to 125 mL/min and (2) racks for 13 mm tubes. Other racks may be substituted; specify racks when ordering .....68-2130-009

Foxy R2 fraction collector with high-flow diverter valve: Includes compression fittings for 1/4-inch OD tubing. Maximum flow rate 1 L/min. Includes (2) racks for 25 mm tubes. Other racks may be substituted; specify rack when ordering .....68-2130-007

### Extra Racks for Foxy R1 & Foxy R2 (Order 2 racks for Foxy R2.)

13 mm diameter tubes (144).....	60-2137-150
16 mm diameter tubes (100).....	60-2137-151
18 mm diameter tubes (72).....	60-2137-152
25 mm diameter tubes (36).....	60-2137-153
1.5 ml microcentrifuge tubes (60).....	60-2137-154
29 mm centrifuge tubes (36).....	60-2137-157
28 mm diameter scintillation vials (36).....	60-2137-156
96-well microplates (2).....	60-2137-159

Set of two racks for (18) 480 mL glass bottles. Each rack holds (9) bottles. Fits Foxy R2 only; requires qty. 1 set .....60-5247-004

96-well microplates (6)  
For Foxy R2 only, requires qty. 1 .....60-2137-139

Preparative funnel rack with 26 ETFE\* or ECTFE\*\* funnels and 50 ft. of 3/8-inch ID vinyl, FEP-lined tubing. For Foxy R2 only, requires qty. 1. Organic compatible .....60-2137-162

Preparative funnel rack with 36 ETFE\* funnels and 50 ft. of 1/4-inch ID vinyl tubing. (Requires 1 rack for Foxy R1; 2 racks for Foxy R2). Non-organic.....60-2137-163

### Interface Cables for Foxy R1 & Foxy R2

HP1100/1200 system for remote start signal and peak separation.....60-5394-474

Non-Teledyne ISCO pump connect cable .....69-2134-170

External control of Foxy R1 or R2 by contact closure or TTL I/O.....69-2134-171

### Accessories for Foxy R1 & Foxy R2

Tubing and fitting package for 25–125 mL/min

Glass bottles, 480 mL, case of 40 .....60-2137-062



For complete information about Teledyne ISCO chromatography products, visit;

[www.teledyneisco.com](http://www.teledyneisco.com)

\* Equivalent to Tefzel, a registered trademark of E.I. DuPont de Nemours & Co.

\*\* Equivalent to Halar, a registered trademark of Allied Chemical Corp.

---

**Teledyne ISCO**

P.O. Box 82531, Lincoln, Nebraska, 68501 USA

Toll-free: (800) 228-4373 • Phone: (402) 464-0231 • Fax: (402) 465-3091

[teledyneisco.com](http://teledyneisco.com)



*Teledyne ISCO is continually improving its products and reserves the right to change product specifications, replacement parts, schematics, and instructions without notice.*



**TELEDYNE ISCO**  
Everywhereyoulook™